



### 8905-TM/9505-TM

**Multiplicador de par manual con compensación con brazos de reacción recto y acodado**



#### DETALLES DEL PRODUCTO

- La gama abarca hasta un par máximo de 2700 Nm
- Utilizar siempre con llave dinamométrica (en sentido horario y antihorario) para no exceder el torsión máximo del multiplicador
- Precisión  $\pm 4\%$
- Suministrado con brazos de reacción rectos y acodados
- Suministrado en un maletín de plástico
- Fabricado en Reino Unido

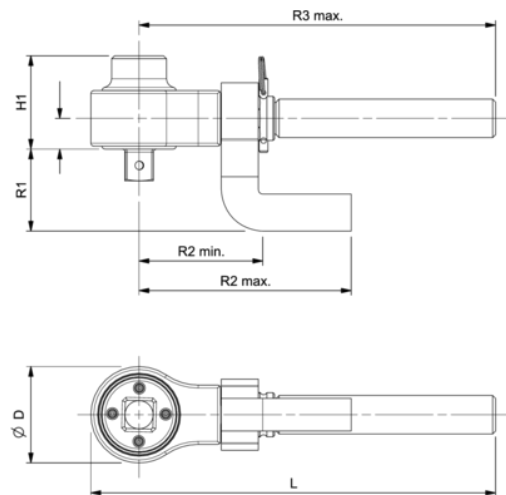









**Follow the Fish!**











## ATRIBUTOS DE PRODUCTO

### Producto: 8905-TM

 1300 Nm		3/4 in		5:1	
 260 Nm		1/2 in	<b>D</b>	108 mm	
R3 max mm	H1 mm	103 mm	<b>L</b>	210 mm	
R2 max mm	R2 min mm	140 mm	R1 mm	77 mm	
 3,8 kg		1.06 kg		1.36 kg	
 3.700 kg					

### Producto: 9505-TM

 2700 Nm		1 in		5:1	
 540 Nm		3/4 in	<b>D</b>	108 mm	
R3 max mm	H1 mm	100 mm	<b>L</b>	210 mm	
R2 max mm	R2 min mm	140 mm	R1 mm	85 mm	
 3,8 kg		1.06 kg		1.36 kg	
 3.700 kg					

Follow the Fish!

