



2477G-200

Alicates de boca semirredonda de punta curvada a 45° con mangos bi-componente y acabado lacado



DETALLES DEL PRODUCTO

- Alicates de boca semirredonda con puntas curvadas en ángulo a 60° con mangos bi-componente
- Adecuado para cortar cable de Cu, Fe y Fe+
- Acero aleado de alto rendimiento
- Superficies pulidas y engrasadas
- Fosfatado, tratamiento anticorrosión
- Con puntas curvadas en ángulo a 45° con mangos bi-componente
- Bocas estrechas, semirredondas y dentadas
- Filos de corte afilados para cortar material blando como cobre y cable aislado de plástico

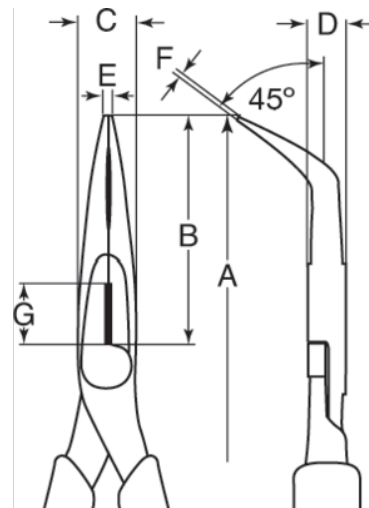





Follow the Fish!







ATRIBUTOS DE PRODUCTO

Producto: **2477G-160**

A	165 mm	B	48 mm	C	18 mm
D	9 mm	E	3 mm	F	2 mm
G	48 mm	 Cu	3.0 mm	 Fe+	1.5 mm
 Piano	1 mm	 g	160 g		

Producto: **2477 G-200**

A	210 mm	B	70 mm	C	22 mm
D	11 mm	E	4 mm	F	3 mm
G	70 mm	 Cu	3.0 mm	 Fe+	1.5 mm
 Piano	1 mm	 g	185 g		

Follow the Fish!

