



BH3HD8000

Soporte de caballete para trabajos pesados



DETALLES DEL PRODUCTO



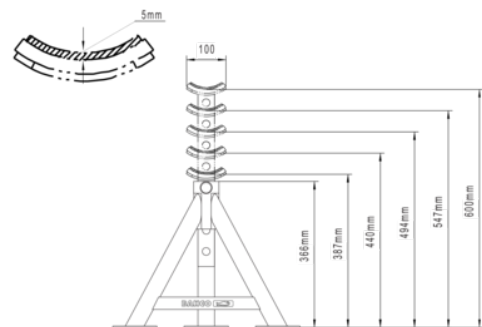



- Caballete para trabajos pesados 8 T
- Sistema de seguridad con pasador con agarre de goma
- Altura máxima de 600 mm
- Soporte especial redondo con goma para facilitar y asegurar las operaciones de carga
- Homologación TÜV y certificado GS
- Venta individual



Follow the Fish!



ATRIBUTOS DE PRODUCTO

Producto						
BH3HD8000	8000 kg	385 mm	600 mm	470 mm	430 mm	9.4 kg

Follow the Fish!

